

# 1. Inside a Computer – Hardware and Software

Aim: In this lesson, you will learn:

The main hardware and software components of a computer.

Functions of different computer parts.



Tejas, Jyoti and their friends along with Moz are examining an open CPU.

Jyoti: Computers are made of electronic parts called **components**. Each component has a specific function. They all work together when a computer is operated. Some of the components can be seen partly from the outside. Some components are inside the computer box where we can't see them.

Tejas: Seeing the components inside a

computer is interesting. Look at the brain of the computer (CPU). Whenever we press a key, click the mouse, or start an application, we send instructions to the CPU. These are all executed by the CPU.

Jyoti: Look at these other components. How can we know their details?

Moz: We can do do by starting the computer and exploring the system then. Lets go to the lab now.

Tejas, Jyoti and Moz move to the computer lab discussing about the inside of a computer.

Jyoti: Can we see the details of the components inside this computer, after logging in?

Moz: Yes. On the desktop, from the taskbar click on the *System* submenu. Under *Administration* click on *System Monitor*, which shows you details and status of hardware and software of the computer.

Jyoti: Hey! There are four processors (CPU) in this computer. There are many details for the processors.

Moz: The processing of your instructions is shared between the four processors, just the way you share work among your team.

Jyoti: What does 2.66 GHz mean?

Moz: This stands for 2.66 Giga Hertz. You know that Mega means million and Giga means billion, a Hertz means cycles per second. CPU needs one or more cycles to perform an action. More cycles per seconds means more instructions can be processed per second. So, the higher the Hertz, the faster the CPU can process instructions.

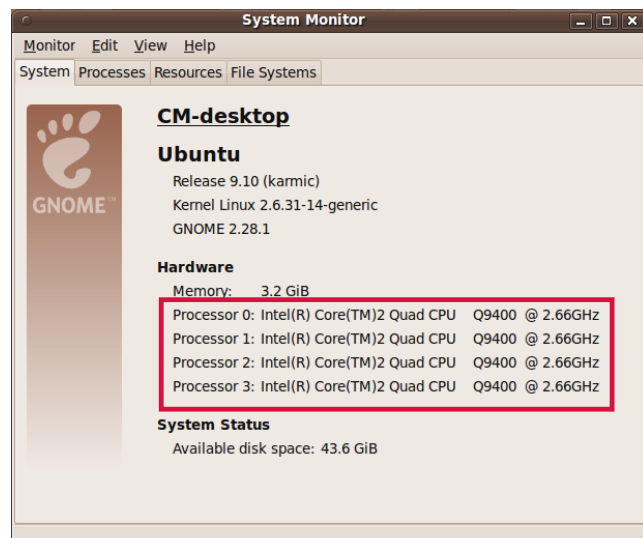

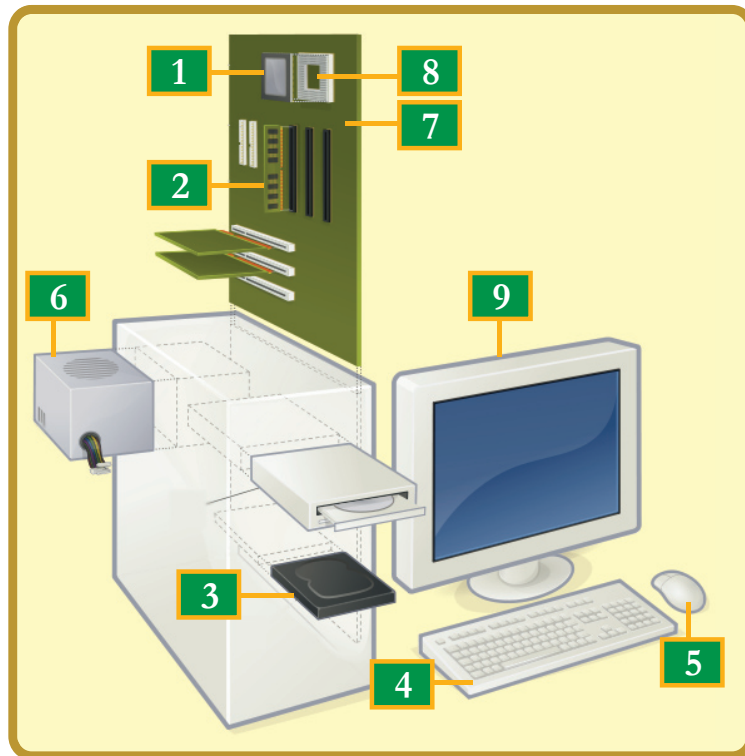

# 1 Processor (CPU)

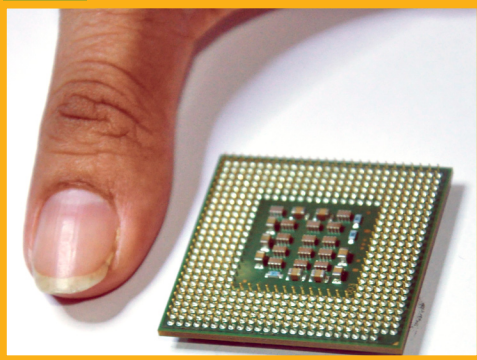

Concept  
Info

The Central Processing Unit (CPU), also called a **processor**, is like the brain of the computer. It executes instructions in response to commands.

- A processor's speed is measured in **Megahertz (MHZ)**, or **Gigahertz (GHZ)**. Higher the hertz, the faster the process in of instructions.
- The CPU is generally a **2 inch ceramic square** with a **silicon chip** located inside. The chip is usually about the size of a thumbnail.

**Central Processing Unit (CPU)**

Executes program commands

Tejas: Main memory is used to store programs and data.  
 Moz: The computer's work takes place in Random Access Memory (RAM). This is where programs executes for example when you using word processor application to create a document or Scratch to create an animation, the instructions are loaded into the RAM.

Jyoti: What does 3.2 GB mean?  
 Moz: Let us first understand how computers store information. Computers store information digitally. All the information stored as numbers, in a binary system. A binary system has only two numbers 0 and 1. (Decimal system has 10 numbers 0.....9.)

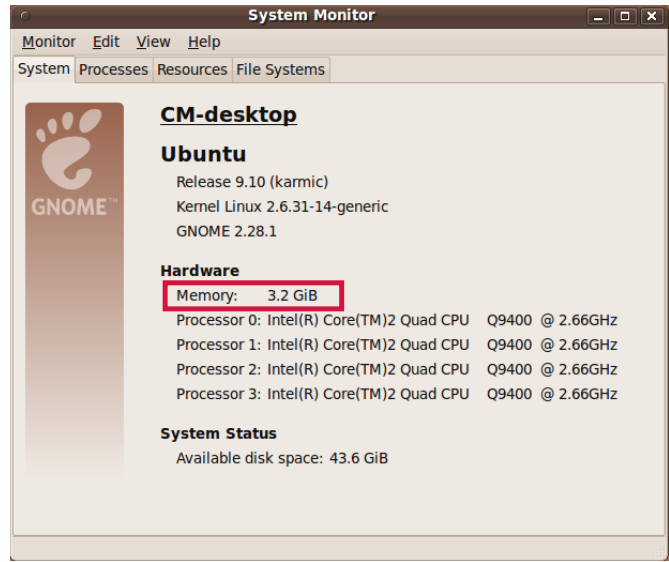

## 2 Main Memory

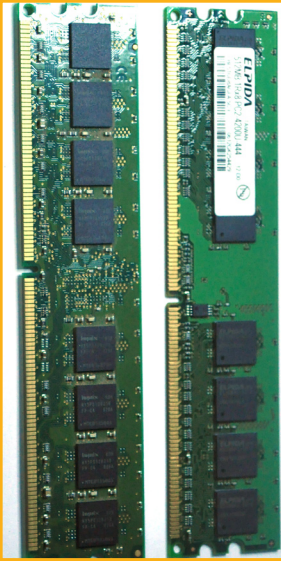

Concept

- RAM (Random Access Memory) is also called main memory. RAM is used to store data and instructions that are currently being processed by a computer's CPU.
- Data is temporarily stored in the RAM till it is saved to the hard disk. The data in RAM is erased when power is switched off.

Info

- RAM is measured in **megabytes (MB)** or **gigabytes (GB)**. A bit is the smallest unit of data in computer processing. It represents a digit in the binary system. So a bit can have either a value 0 or value 1. A byte is a group of eight bits.
- A **Kilobyte (KB)** is  $2^{10}$  bytes or approximately 1024 bytes. A Megabyte (MB) is about one million bytes. A gigabyte (GB) is 1,024 megabytes.
- The **more RAM** a computer has, the more things a computer can access at the same time. So more the RAM, the **faster** a computer performs tasks.

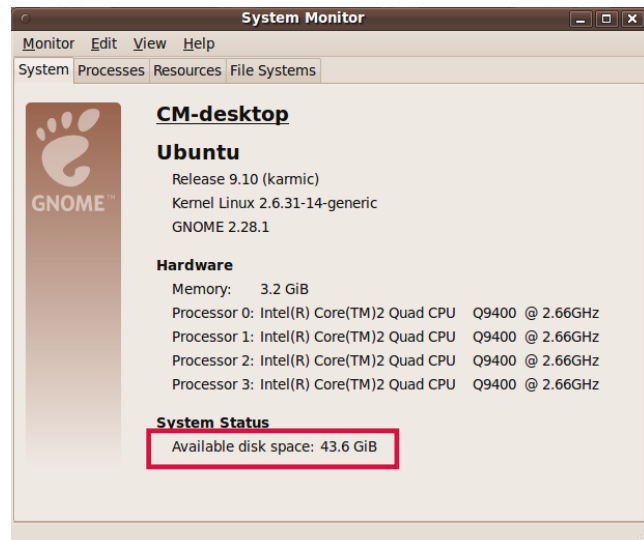
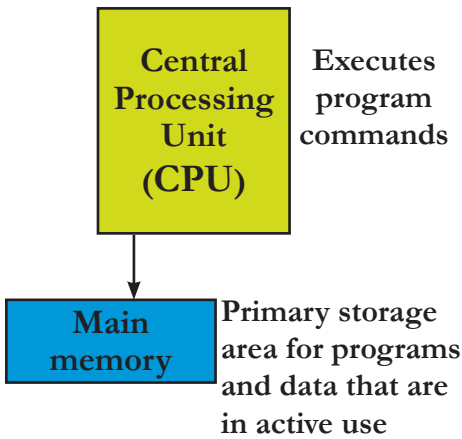

Jyoti: When we save data in an application, the content is written into secondary storage.

Tejas: Whatever information we save on a computer, is written to the hard disk, which can be retrieved later. It is like a permanent storage device.



CD



Pendrive

Moz: The hard disk stores multiple type of data and applications. The documents and content that a user creates and saves, the software to operate the computer and the applications like Word processor and Scratch, are stored on the hard disk. The computer loads the instructions from secondary storage (hard disk) into

main memory as and when required.

Jyoti: The amount of data and programs that we can store on a hard disk depends on its size, which is measured in giga bytes.

### 3 Secondary storage (Hard disk)



Concept

- Secondary storage is where the information is stored permanently till explicitly deleted. Information is moved between main memory and secondary memory as and when needed.
- On power off of a computer, data on hard disk and other secondary storage devices is not erased.

Info

- The hard disk drive is the data center of the computer. Operating system, software, content (created and saved by users) are stored here until explicitly deleted. The hard disk drive is usually found inside a computer.
- CD/DVD and pen drive are removable storage devices. These can be used to backup important data and information. They also sometimes used to distribute, share information or transfer information from one computer to another.

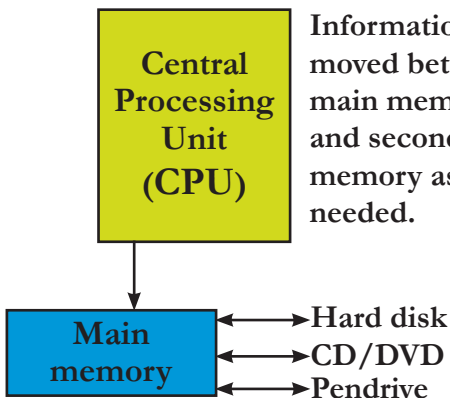

Information is moved between main memory and secondary memory as needed.

Tejas: We can also record data to CD/DVD or pen drive. The memory of these devices is usually not as much as a hard disk drive.

Moz: Correct. These devices are called removable storage devices. These can be removed from the computer and carried wherever required. (The hard disk is also sometimes removable.)

Jyoti: A few days ago I created a greeting using the computer. I saved it on the hard disk and also copied it on to a pen drive. Next day the computer did not work.

But since I had a copy on the pen drive I could copy it on to another computer and mail it to my friends.

Moz: Making a copy of a document or information that you create on the computer, is called taking backup. **Backup** of content (documents, paintings, reports, etc.) that you create is important. Backup can be taken on CD/DVD, pendrive, a removable hard disk, or another computer to which you have access.

Tejas: We can also mail a copy to ourselves if we have Internet connectivity.

Moz: Right. This is good option when you have Internet connectivity.

#### Backup

Concept

Backup of data and information that you create is important. Many backup options are available, like mailing a copy of the content to yourself, taking a backup on pen drive, a CD/DVD or another computer. This ensures that even if one device fails you have a copy of the content that may be accessed using another computer.

Jyoti: We also get books, games, educational lessons on CD/DVDs.

Moz: Correct. These devices can also be used for distribution and sharing of resources.

Jyoti: We already know what are input and output devices. Examples of input devices are keyboard, digital camera, and mouse. Printer and Monitor are examples of output devices.

Moz: Correct. User interacts with the computer using these devices. These are also called **peripheral devices**. The electrical signals for the alphabets typed on a keyboard, are converted to binary system and stored. When the computer displays the data on a monitor or when output is a printout, the binary system is again converted to electrical signals and then to the human understandable characters.

Tejas: Oh! This is how input to output happens in a computer.

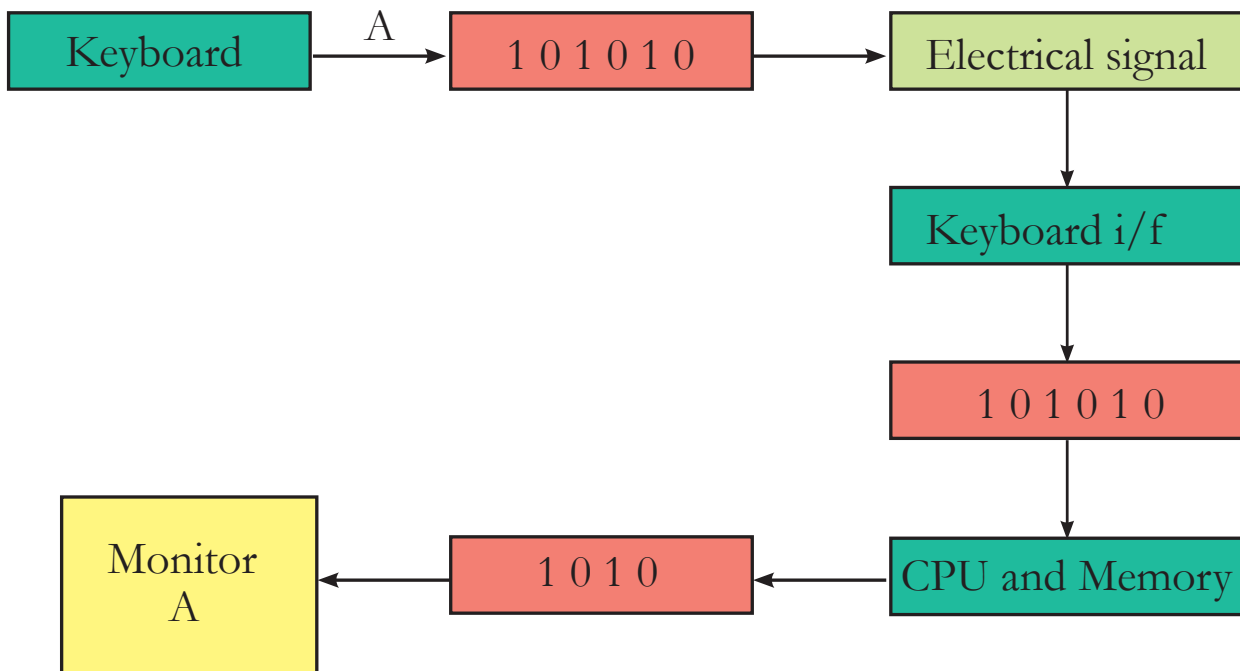

## 4 Input/output (I/O) devices



Concept

- An input device converts data and instructions entered using the device into a pattern of electrical signals. These signals correspond to binary code that can be processed by a digital computer. A user inputs data and instructions (Example: using a keyboard), initiates a task (Example: using a mouse), transfers images (example: using a web camera), using the input devices.
- An output device reverses the process, translating the digitized signals into a form intelligible to the user. The computer displays processed information (example: a print out of the information or audio, video) through the output devices.

Info

- Keyboard, mouse, scanner, webcam are examples of input devices.
- Monitor, printer, speakers are examples of output devices.
- Some devices can handle both input and output. The network device (called network card) in a computer is both input and output device.



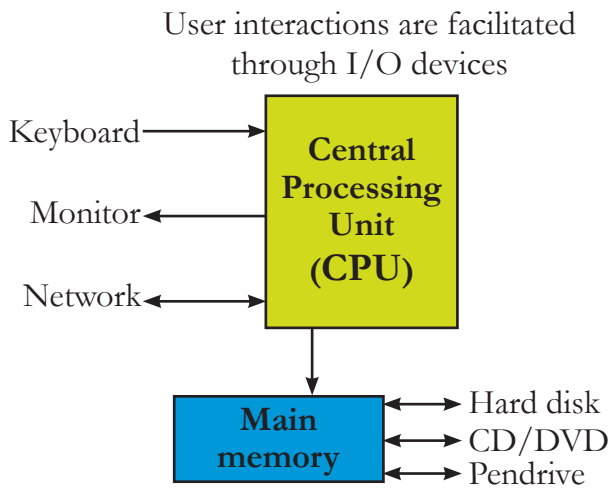

Tejas: At the back of the computer we find many sockets. These are called connection ports used to connect the external devices like keyboard, mouse, speakers, power, monitor, and to the CPU.

Jyoti: Ports are of different shapes and sizes. Some examples are network port, USB port and printer port.

Moz: The ports look different since they carry different amounts of information. The colour code and look also helps to quickly identify the correct port while connecting peripherals.

## 5 Connection Ports



Concept

- A port is an interface between the computer and other computers or peripheral devices. It provides a signal transfer between devices.

Info

At the back of a desktop computer various connection ports are available to connect the external devices and power. On a laptop these are available on the left and right side edges. Some common ports and their details are as follows:

1. PS/2 Port: Used to connect the mouse and keyboard.
2. Ethernet Port: Used to connect the network cable.
3. Audio In/Audio Out: Connect various devices, including speakers, microphones, headsets, and more Audio.
4. VGA Port: Monitor is connected to this port.
5. USB Port: The Universal Serial Bus port is one of the most useful. These USB ports let you attach a variety of devices such as mouse, printers, keyboards, web cameras, USB/flash drives, and digital cameras to the computer quickly. Most peripherals have a USB version.

Tejas: The computer has a power supply from which all the components get power.

## 6 Power Supply

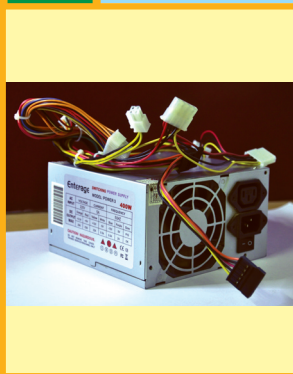

Concept

The power supply unit in a computer converts the power from the wall outlet to the type of power needed by the computer.

Info

- The power supply unit sends power through the cables to the motherboard and other components. The power cable from a wall outlet is connected to a socket in this unit.
- The power On button for a computer is usually available on the front panel on a desktop and for a laptop it is usually available above the keyboard.

Jyoti: The circuit board which holds some of the components like CPU, ROM and has connectors to other components of the computer is called the **Motherboard**.

Moz: Yes. The motherboard connects directly or indirectly to every part of the computer.

## 7 Motherboard



Concept

- Motherboard connects directly or indirectly to every part of the computer. The motherboard's main job is to hold the computer's microprocessor chip and let everything else connect to it.
- Everything that runs the computer or enhances its performance is either part of the motherboard or plugs into it via a slot or port.

Info

- The motherboard is the computer's main circuit board. It's a thin plate that holds the CPU (Central Processing Unit), memory, connectors for the hard drive and optical drives, as well as various external ports and peripherals.
- A port is connected from inside to expansion cards which are plugged into the motherboard and are connected to other components by cables which are long, flat bands that contain electrical wiring. The ports are controlled through the expansion cards.

Moz: Now that all the parts are together how do you start a computer? How does the CPU control all the components?

Tejas: We need software to operate the computer.

Moz: What is software?

Jyoti: Software is the instructions, telling a computer what to do. Software is required to operate and use the computer. These are BIOS software, Operating system and Application software.

Jyoti: Firstly when we power on the desktop, software called Basic Input Output System software (BIOS) starts or boots the computer. This software resides on a small chip called ROM (Read-Only Memory) or flash memory. The ROM is physically integrated into the motherboard.

Tejas: BIOS checks whether all the hardware units are working. When we switch on a system, we see many messages informing that a particular hardware is working fine. These are from BIOS. Then the BIOS loads the operating system.

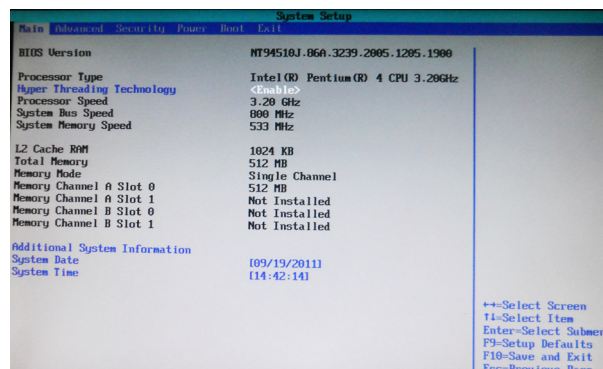

Normal  
Screenshot  
of BIOS

Jyoti: If a hardware is not working, for example if a hard disk is not working, then the BIOS gives a message as follows:

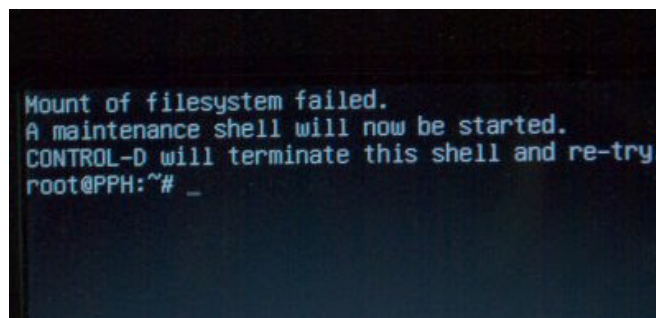

Error  
Screenshot  
of BIOS

Moz: The most important role of BIOS is to load the operating system (OS). When you turn on your computer, the CPU needs instructions that tell it where the operating system is located on a hard disk. The BIOS provides those instructions.

## 8 BIOS software and booting

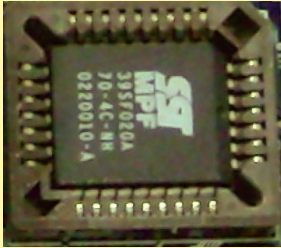

### Concept

- Basic input output system (BIOS) is the first software that runs on a computer when power.
- First task of BIOS is to initialize and identify devices such as the display card, keyboard, mouse, hard disk, CD/DVD drive and other hardware. Next task of the BIOS is to find the operating system software that is provided on a hard disk or a CD and load the operating system. BIOS then gives control of the computer to the OS. This process is known as booting.

### Info

BIOS are usually stored on a Flash memory, an electronic chip on the motherboard. Flash memory provides fast, permanent storage and can be easily updated. Some of the other devices where is used are digital cameras, gaming devices.

Tejas: Next the operating system takes over and we can start using the computer.

Jyoti: When we work on a Word document, print an email, and use Internet browser at the same time, then it must be the OS that manages all these actions.

Moz: Yes. These three programs need attention from the central processing unit (CPU) to do the tasks. These programs also need memory and storage, and need to be able to send messages to devices such as the mouse and the printer to accomplish these tasks. The operating system is responsible for handling these applications and peripherals.

## Operating System software



### Concept

- The operating system is responsible for managing the computer's hardware and software resources. It controls the memory needed for computer processes, manages disk space, controls peripheral devices, and manages user communication with the computer.
- The difference between BIOS and Operating system is that BIOS has very limited instructions. At the end of the booting process it hands over the control to OS. Starting from user management to application execution, input, output, processing, controlling devices all are handled by the OS.

### Info

- Operating system is software that is installed on the hard disk. There are many operating systems available. Example: Linux (Ubuntu, Redhat, Debian), Windows (Vista, XP) and MAC OS.
- The operating system loads at the end of booting process. From this point, the operating system begins to control the way in which the computer functions.

Tejas: We already know about the application software. We have used quite a few of them, such as Scratch, word processor, email application and games. We can also install new application software as and when required.

Moz: Any software, whether it is BIOS software or Operating system or application software, consists of instructions written by programmers. Specific programming languages are used to build each software.

### Concept

#### Application software

Applications are software written using a programming language. Applications are programmed to perform specific tasks.



## Application software

### Info

There are many types of applications like a browser application, a word processing application, a game playing application, an application to paint or build an animation, an email application and so on. New applications can be installed on a computer as and when needed. These applications reside on the hard disk.

Tejas: All the hardware and software components work together and provide us a visual display on the monitor of the output. Monitor is also an important part of the computer. It is connected externally to the correspondent port.

Jyoti: There are different types and sizes of monitors. On some, the images are shown very sharply. Why is it so?

Moz: The display depends on the resolution of the monitor. The monitor has a number of dots, horizontal and vertical which are called pixels. More the pixels on a display, sharper the image. Resolution refers to the number of individual horizontal pixels and vertical pixels on a display.

Example: 800x600, 1200x1024.

Tejas: So if the number of pixels of a sharp image, are spread out over a larger number of inches, then the image becomes blurred.

## 9 Monitor



### Concept

- A monitor is one of the output devices of a computer. The display sharpness depends on the size and resolution of the monitor.
- A monitor has a number of individual dots known as pixels. Resolution refers to the number of rows of dots and the number of columns of dots.
- The size of display depends on two factors:
  - The aspect ratio (the ration of width to the height of the screen)
  - The screen size (measure from one corner to the other corner diagonally opposite).

### Info

- Currently LCD technology is commonly being used for monitors. There are many sizes of monitors. Popular screen sizes are 15, 17, 19 and 21 inches.
- The resolution of screens varies. Example: 800x600 pixels to 1200x1024.
- For professional applications, such as medical imaging or public information displays, monitors as large as 40 inches or larger, with higher resolutions, are being used.

Tejas: It was very interesting to know how so much work happens inside a computer.

Moz: Now you know how the components of a computer, both hardware and software, work together to complete the tasks. Chin Chinaki...

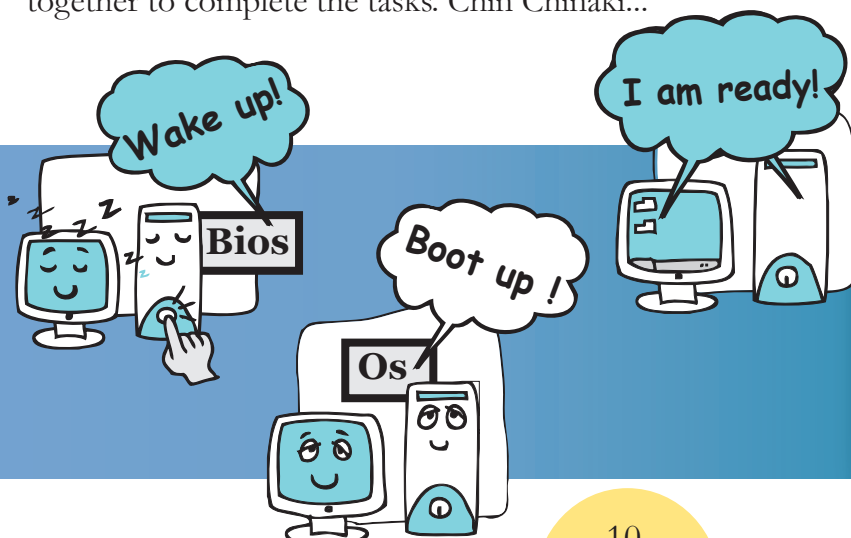

## Lesson Outcome

At the end of this lesson, you will be able to:

- Categorize a computer component into hardware and software.
- Identify various parts inside the computer and state their functions.
- Define BIOS, OS and other software.

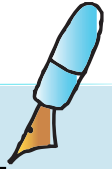

1. Classify the following as Hardware or Software. Write H or S next the word.

Drive	H/S	Drive	H/S
Motherboard		BIOS	
Monitor		Word processor	
USB Port		Linux	
Windows		Ubuntu	
Pen drive		Cellphone	
RAM		Scratch program	
ROM		Printer	
Tux paint		Scanner	
Childs play		Web cam	
Internet browser		CD	
Keyboard		Quick time Media player	
Hard disk		I pod	
Powepoint		Speaker	
Impress		Microphone	
DVD Drive			

2. Fill in the blanks.

a. Identify the following pictures.

Hard disk  
Scanner

Motherboard  
DVD player

Pen Drive  
Flash memory

RAM  
CD drive

Power supply  
CD

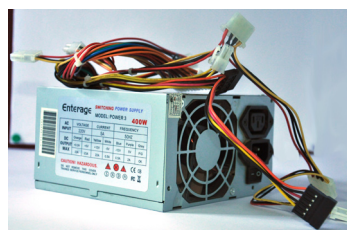
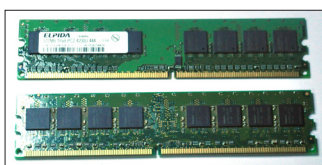
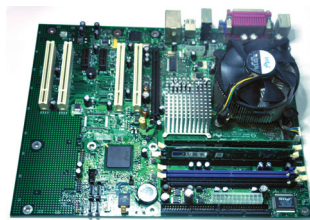

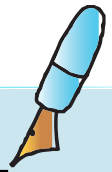

- b. Fill from above list.
- The documents and content that we create and other applications like word processor, Scratch are stored on the \_\_\_\_\_ .
  - The \_\_\_\_\_ is the computer's main circuit board which holds the CPU.
  - To back up your data, you can use a \_\_\_\_\_.
  - The \_\_\_\_\_ is an example of a peripheral device that is used to scan documents and photographs.
  - The \_\_\_\_\_ unit sends power through the cables to the motherboard and other components.
  - \_\_\_\_\_ is the computer's short term memory.
  - The software which initialiser major hardware components of the computer resides in a \_\_\_\_\_ . This software also startts the \_\_\_\_\_ .

### 3. Play scrabble.

Choose required number of letters from the scrabble rack and unscramble them to answer the questions, as shown below.

Question	List of rack images with jumbled letters	The rack image with blank tile
You normally do this to keep a copy of important documents.		
Computer uses this system to store information digitally .		
My resolution can be changed for picture clarity.		
I am the storage area responsible for storing active applications.		

### 4. Which of the choices below are NOT a function of the Operating system.

- It controls the memory needed for various processes.
- It controls peripheral devices.
- It controls the booting of a computer.
- It manages the user's communication with the computer.



5. Fill the missing information.

Component	Corresponding Units of measurement
Monitor screen	Pixels
Size of the monitor	
Microprocessor speed	
	GB,MB

6. What are two ways to store the data in each of the following cases?

- a. Neela is working on a presentation at home. Tomorrow, she has to take it to her office and give the presentation. Her computer has an Internet connection, CD/ DVD drive and a USB port. Her company also has Internet connection at their premises:

---

- b. Parul is doing her home work on her home computer, which does not have an Internet connection. She has to take the work to school and show it to her teacher:

---

- c. Sai is writing an essay using the word processor, on a computer in the school. He wants to take the essay home to work on it. The Computer does not have a CD/DVD drive and but has a USB port. It also has an Internet connection:

---

7. Tanvi has typed a story and saved it on the computer.

- a. Where will the data get saved?  
(Hard disk                      BIOS                      Monitor)
- b. If now she is editing the story without saving it, where will the data be kept?  
(OS                      RAM                      ROM)
- c. While she was working, the power went off suddenly, what could happen to the edited information? Pick all the right answers.
- It can be partially recovered when you start the application the next time.
  - It is stored in the main memory of the computer.
  - The information is lost and cannot be got back.
  - It gets saved on the Desktop of the computer.
- d. What should she do, to avoid losing most of the data even if the power goes off suddenly?

---



---



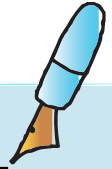

8. Fill in the crossword.

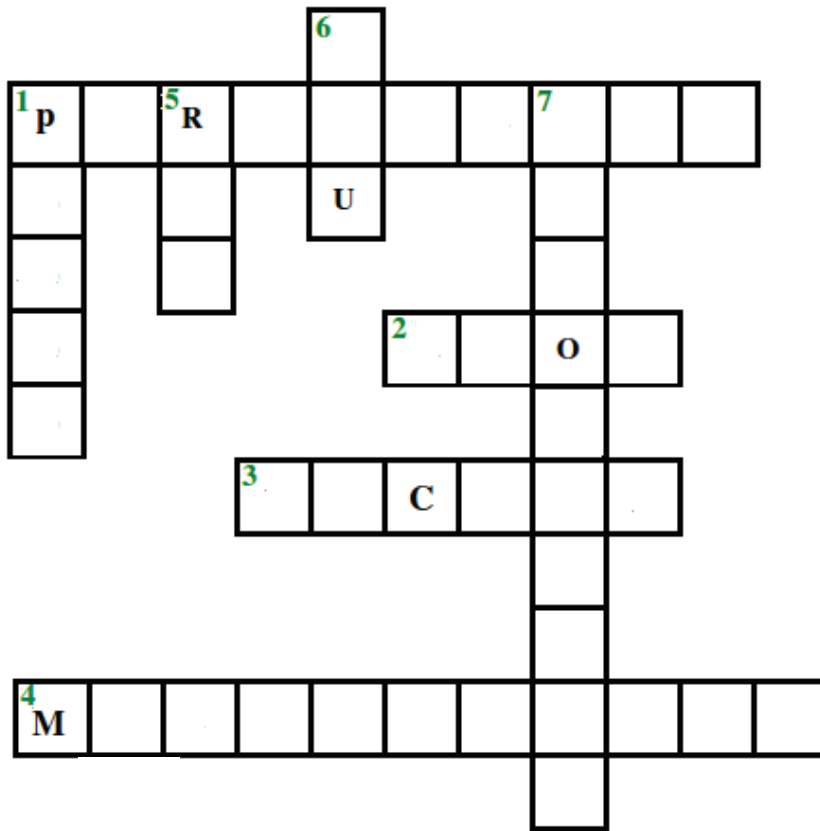

Across

1. Through us a user interacts with the computer : \_\_\_\_\_ devices.
2. I am the software which interfaces the major hardware components of the computer with the operating system.
3. I am the duplicate (another copy) of the content that you create on the computer.
4. I am the main circuit board of a computer.

Down

1. We are used to connect the external devices and power supply to a computer. My anagram is torps.
5. I am also called the main memory.
6. I am the brain of the computer.
7. The sharpness of the display increases as the \_\_\_\_\_ increases.  
Hint: The number of (horizontal x vertical) pixels.

9. Where do the following reside?

Application software	
BIOS	
Operating system	
Unsaved data in word processor	

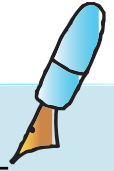

**10. Fill in the appropriate blanks with the following terms.**

- |             |          |                    |
|-------------|----------|--------------------|
| Application | Hardware | Peripheral devices |
| RAM         | Pendrive | BIOS               |
| Printer     | Mouse    | Keyboard           |
| CD          | Webcam   |                    |

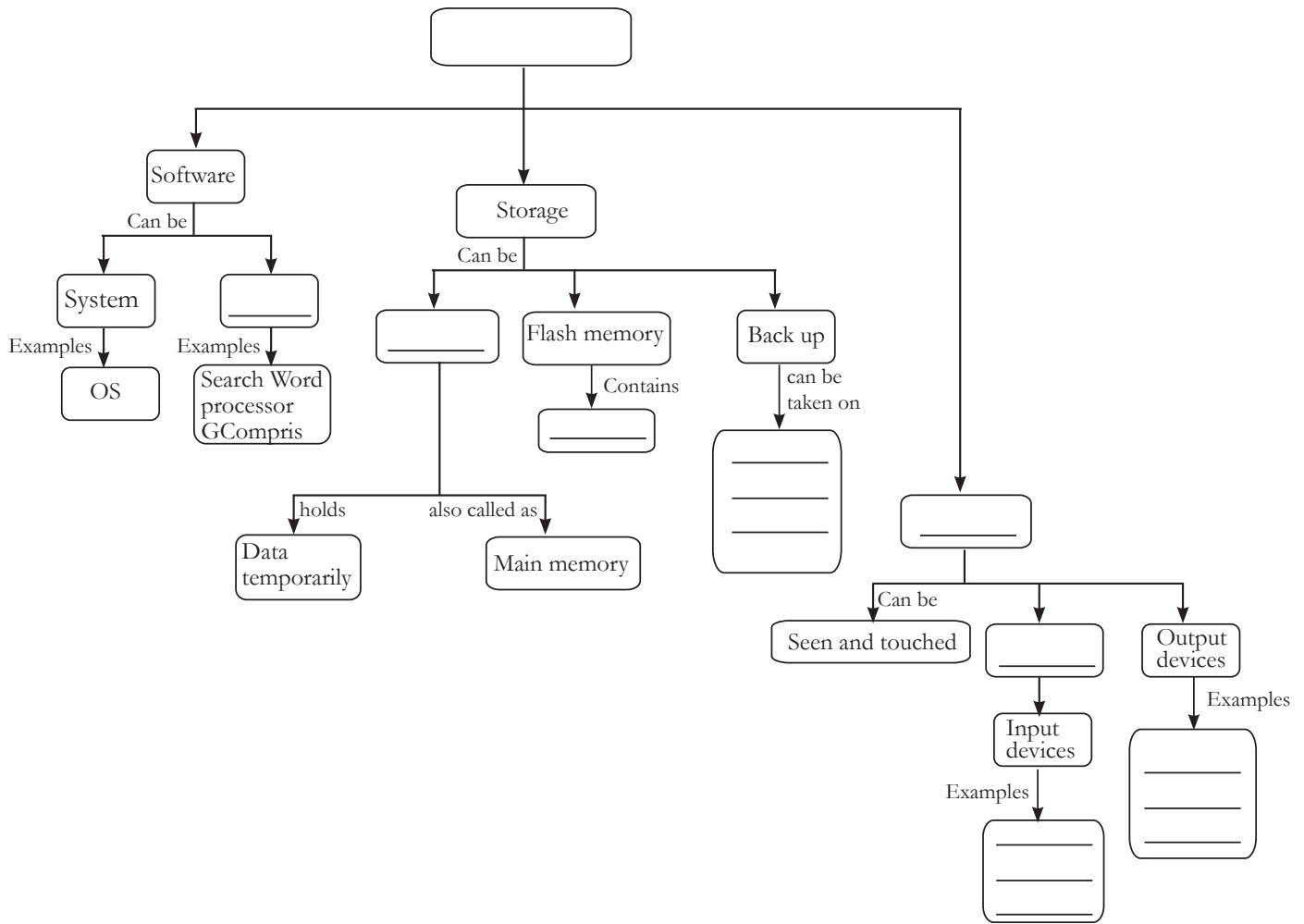

**11. Arrange the following sequentially. First step is already filled.**

a.

Bootling starts	
Start browsing the Internet	
BIOS checks hardware components	
OS starts controlling the functions of the computer	
Computer gets power supply	1
BIOS load the operating system	

b.

User enters the user name and password	1
Word processor application opens	
OS loads the word processor application	
Icon for Word processor application on the Desktop is clicked.	
OS checks the login details and allows user to login	
OS receives the mouse click command	



# ACTIVITY

Level VII | Lesson 1

## Computer based activity (requires Internet)

### 1. Multimedia scrapbook

- Open the following URLs and study the content available:
  - <http://www.kids-online.net/learn/click/table.html> - [here you can click on a computer part inside CPU and learn more about it]
  - <http://www.videojug.com/film/what-components-are-inside-my-computer> [video of components inside a computer]
  - <http://resources.kaboose.com/brain/comp-les2.html> [computer connections - hardware on the inside]
- Find some pictures, texts, anecdotes that you like and save them.  
Remember to check the Web page for a copyright notice. Another good practice is to contact the website ask for permission to use the contents.
- Organize the collected information from the above websites to create your own scrapbook.

### 2. Sampler activity:

- Open the following URLs and study the content available:
  - <http://www.liutilities.com/how-to/assemble-a-computer/> [list the steps to assemble a computer]
  - <http://computer.howstuffworks.com/pc.htm/printable> [picutre of an open CPU with internal parts labelled and video describing how the various components work together in a basic operating session]
  - [http://library.thinkquest.org/C006657/electronics/hardware\\_inside\\_a\\_computer.htm](http://library.thinkquest.org/C006657/electronics/hardware_inside_a_computer.htm) [description of motherboard, processor, memory, disk drives]
  - <http://www.comptechdoc.org/hardware/pc/begin/index.html> [detailed description every computer part including peripherals]
- Write a short paragraph to describe the content you read on the above websites. Summarize as Mind map.

### 3. Find images of different parts inside the CPU. You can use a variety of resource for this, such as computer magazines, Internet, brochures from computer vendors, books, etc. Paste the pictures on cardboard and show the process of how they operate to ensure that the computer is up and running well.

## Group Activity

- Set up a skit where the different parts insider the CPU talk to each other and ensure that the computer works appropriately. Explain the functions of each part. The student who acts as power supply initiates the process.

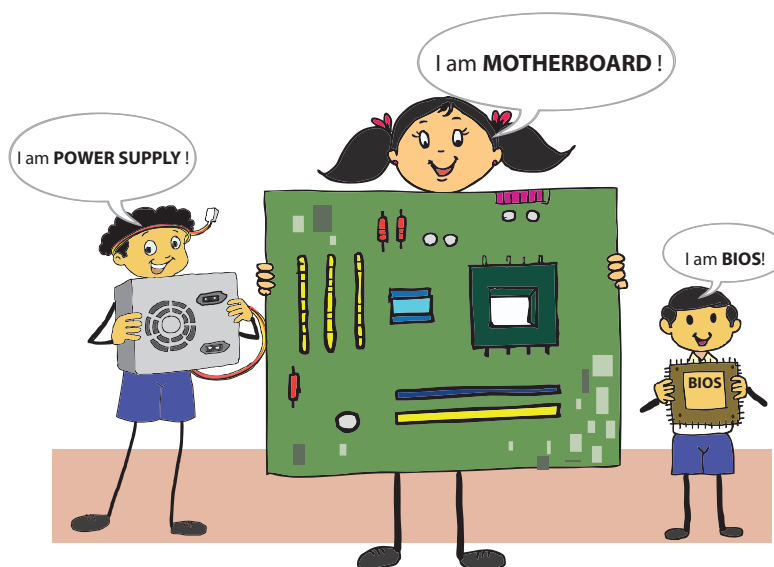



## Project

### 5. I know how it works.

Form groups of 5 students. Each group picks up one of the following devices that are used for various purposes.

- Car
- Washing Machine
- Microwave oven
- TV
- Mobile

i. What are the uses of the device?

ii. Find the major parts of the device, by searching,

*Hint: You can find out about the item from the internet, a shop that sells these devices, instruction sheets or brochures about these devices.*

iii. Does the device connect in different sizes?

iv. What are the major functions of each part of the device?

v. Which are the main parts of the device on which the various features of the device depend on? For example the number of people who can travel in a car depends on the size of the car and the seating arrangement in the car.

vi. Give a few examples where a computer is used in the device.

vii. Prepare a presentation and share it with other groups.



1. Explore how CPU hardware has evolved in terms of size and location.
2. Identify slots on the PC for keyboard, mouse, speakers and mike, note the color coding.
3. What is connecting using Bluetooth?



- This lesson educates students about various internal parts of the computer. Students are already familiar with input and output devices and have an understanding that CPU is the brain of the computer where it processes the information. Begin the lesson by revising this. Tell them that in this lesson, they will learn more about the different parts and their functions.
- If you have access to a non functioning system, open its CPU and ask students to observe what they see. Else, show them a simulation of how the different parts inside the CPU look (url: <http://resources.kaboose.com/brain/comp-les2.html>). Explain the details of different parts such as power supply, mother board, hard disk, RAM along with units of their measurement. Elaborate on the distinction between RAM and ROM and which of the two is active in which activity. Refer the different concept boxes in the lesson for this. If possible, show them either actual parts, else you can show the pictures.
- Students would be familiar with different computer peripherals. The teacher can show them pictures of different forms of the various computer hardware (example: CPU sitting in a cabinet besides the monitor, below it or inside it).
- Assimilate their new knowledge on different internal parts with their prior knowledge on input and output devices. Tell them that the observable parts are referred to as hardware whereas the different applications such as games, word processor, presentation are labelled as software. Ask them where do you think these are stored. Use this opportunity to establish how the hardware and software work together for us to be able use the computer.
- Now teach them the difference between software and hardware. You can say that software is a general term for the various kinds of applications/programs used to operate computers while hardware describes the physical aspects of computers and related devices. You can teach about operating system here. Mention that software is divided into applications and system software. Applications allow us to do various activities such as process documents, play games, prepare presentation. System software includes operating system. Refer the different concept boxes on hardware and software for further explanations.
- Give a demonstration of how to view CPU details. Draw their attention to the different units of measuring computer speed and size of hard disk.
- Educate the students how to measure the size of monitor and identify/change screen resolution.
- Teach the students about the primary and secondary storage devices and importance of taking backups of important data on the computer.
- To reinforce understanding of the functions of various computer parts do the group activity (role play) included in the lesson.

Further Reading:

<http://computer.howstuffworks.com/inside-computer.htm>

[http://en.wikibooks.org/wiki/How\\_To\\_Assemble\\_A\\_Desktop\\_PC/Assembly](http://en.wikibooks.org/wiki/How_To_Assemble_A_Desktop_PC/Assembly)

<http://www.comptechdoc.org/hardware/pc/begin/hwmotherboard.html>

[http://www.kids-online.net/learn/c\\_n\\_1.html](http://www.kids-online.net/learn/c_n_1.html)

<http://resources.kaboose.com/brain/comp-les2.html>